

### Product & Hook-up Information

<b>Body:</b>	Forged Brass with EPDM O-Rings	<b>Supply:</b>		<b>Return:</b>	
<b>Flow Cartridge:</b>	Series 300 Stainless Steel Wear Surfaces with Stainless Steel Spring	Ball Valve 20 Mesh Strainer Drain Valve with Hose End & Cap Pressure/Temperature Port Union Connection to Coil		Union Connection to Coil Pressure/Temperature Port Manual Air Vent Union Connection from Control Valve Automatic Flow Regulator Dual Pressure/Temperature Ports Ball Valve	
<b>Accuracy:</b>	±5%				
<b>Rating:</b>	400 psig at 250° F (2758 kPa at 120° C)				

### HU-A Models

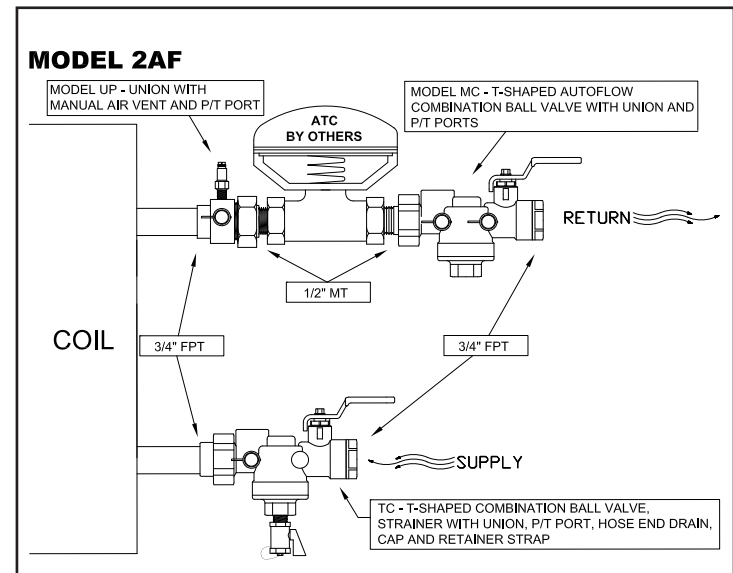
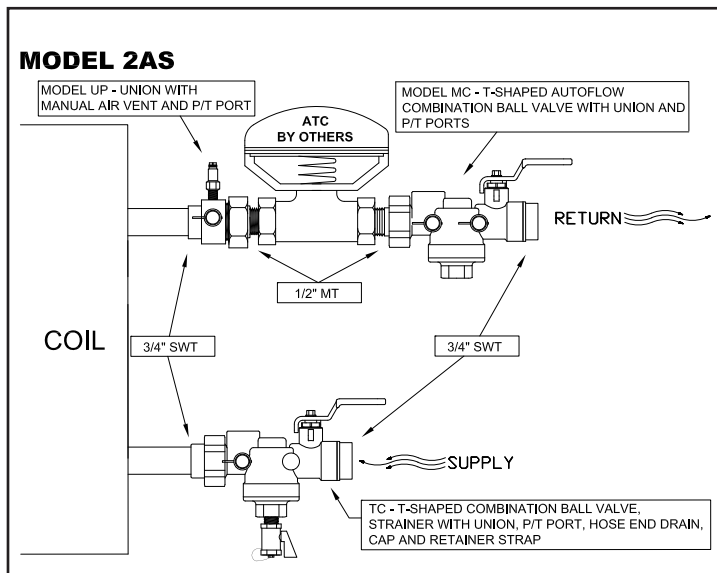
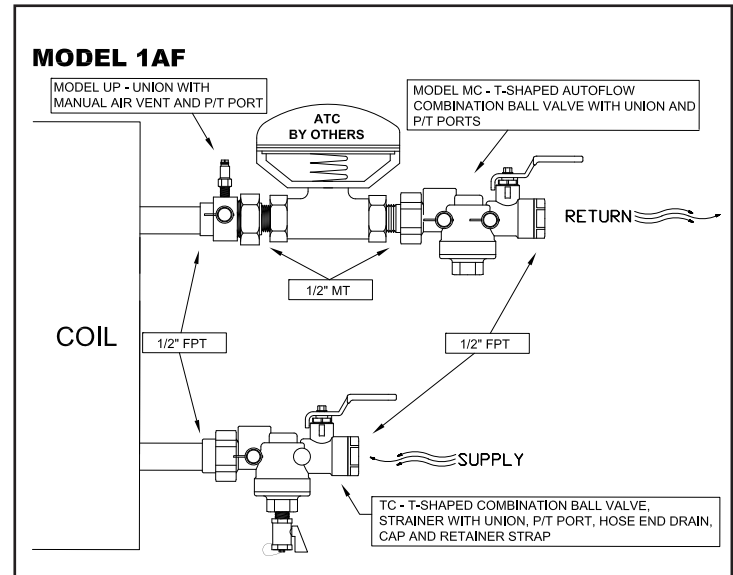
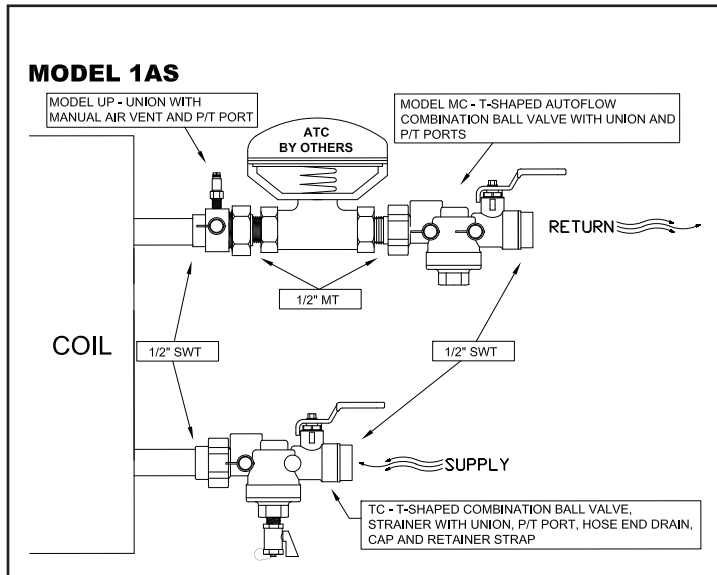

## HU-A Models

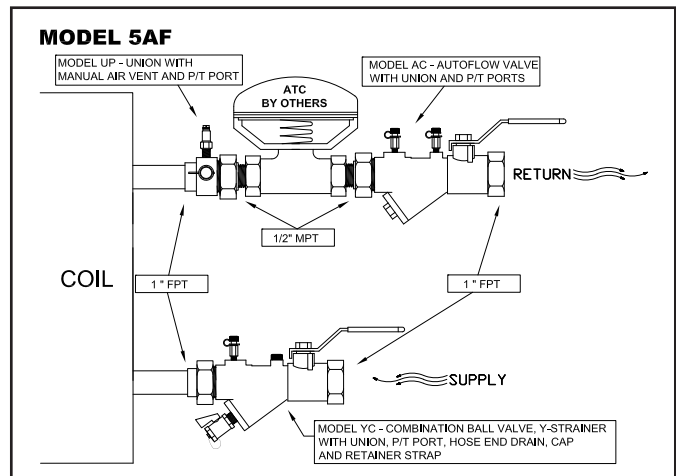
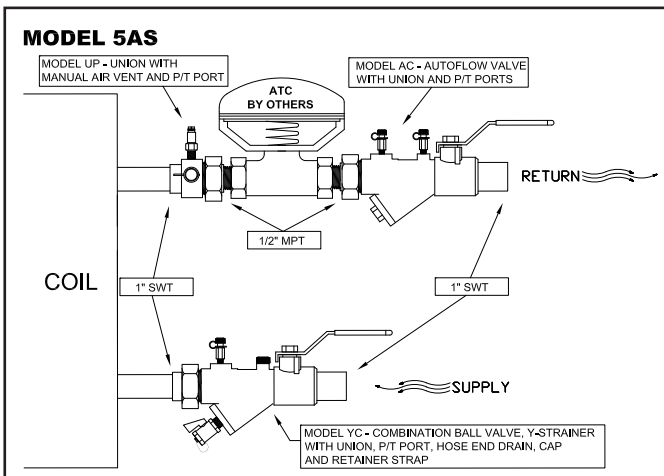
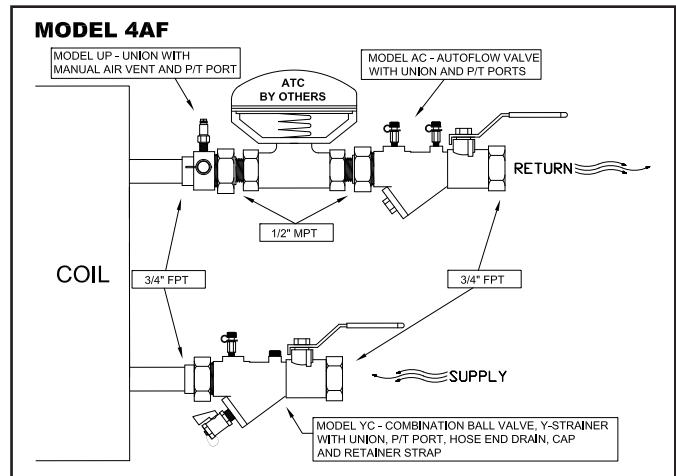
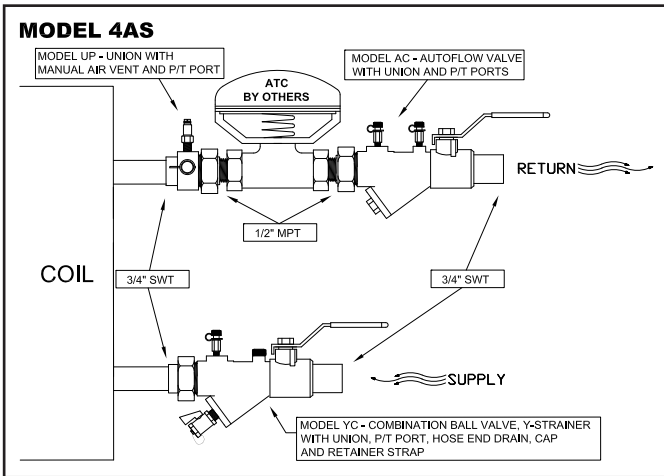
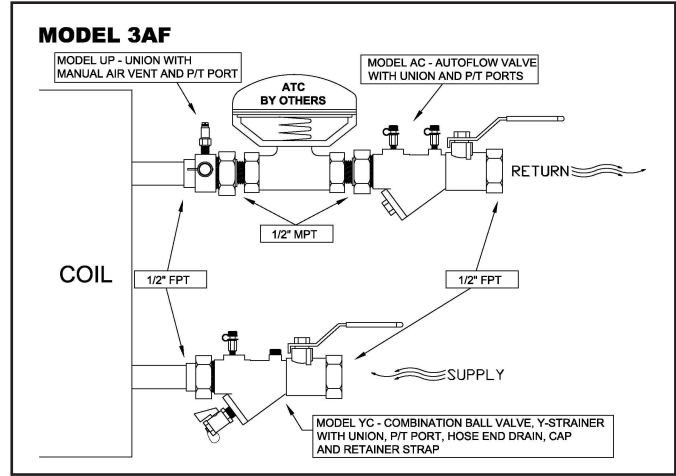
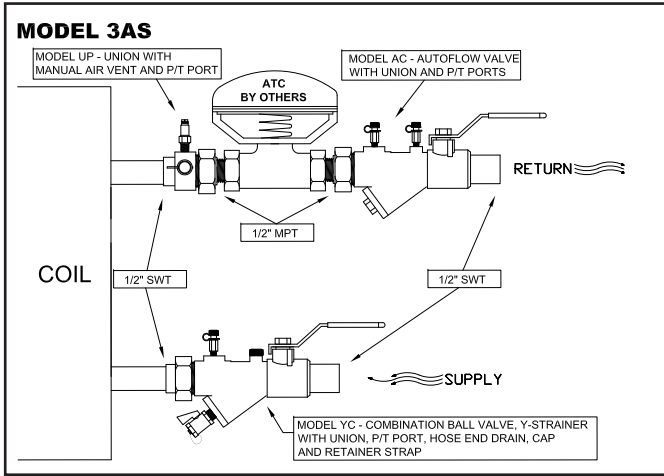

## HU-A Models

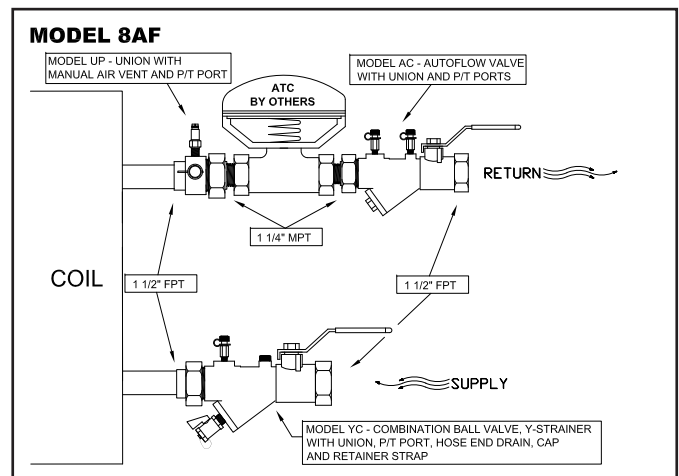
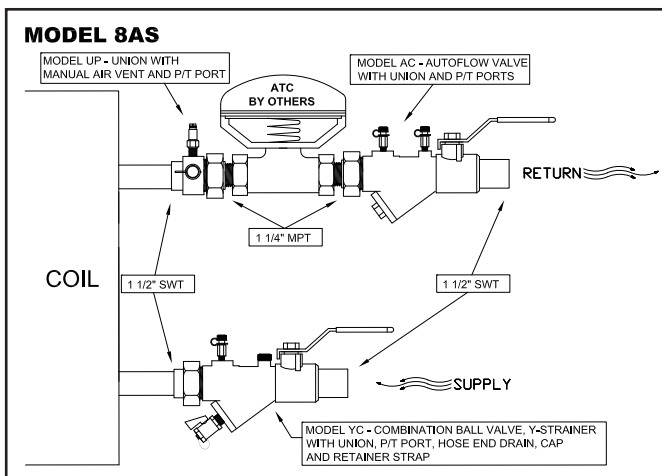
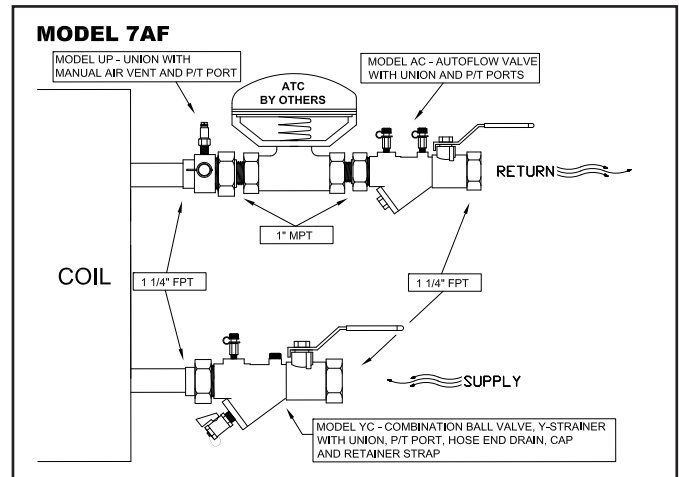
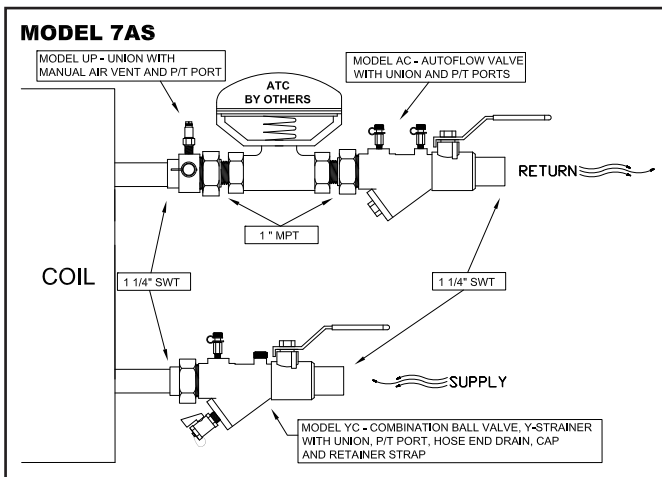
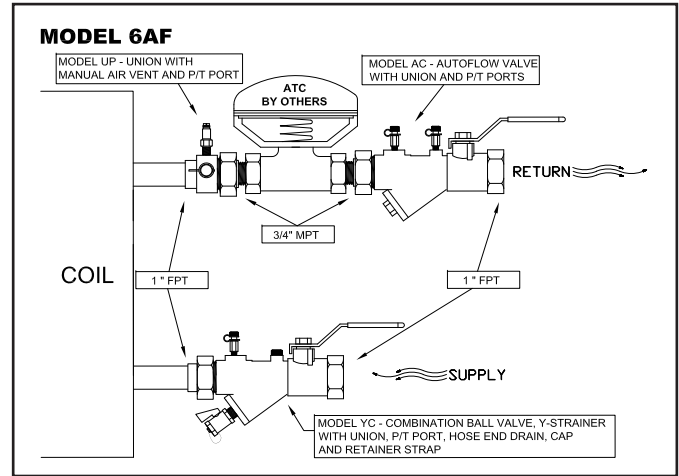
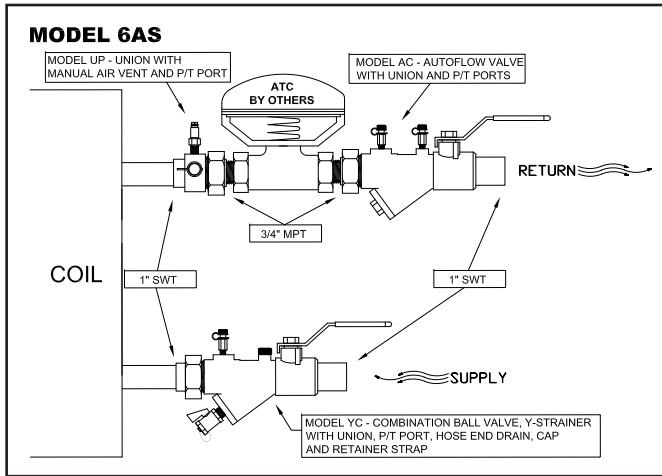

#### HU-A Models

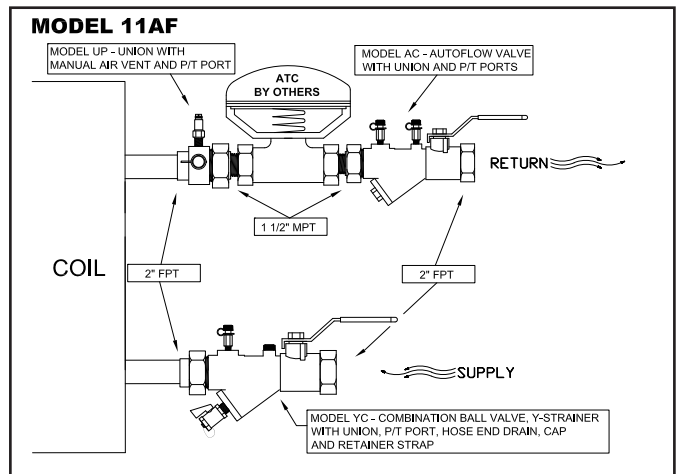
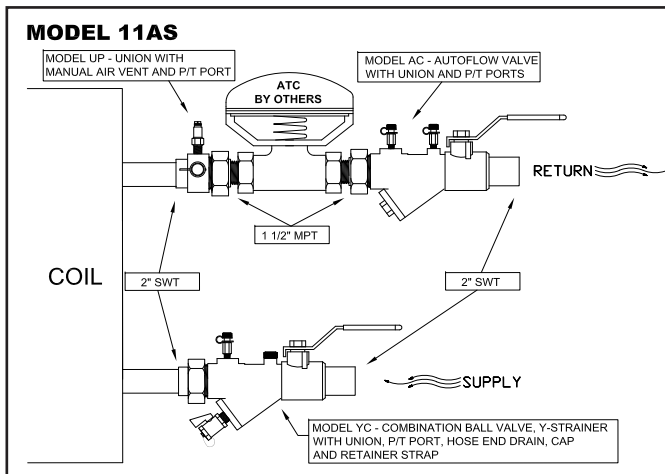
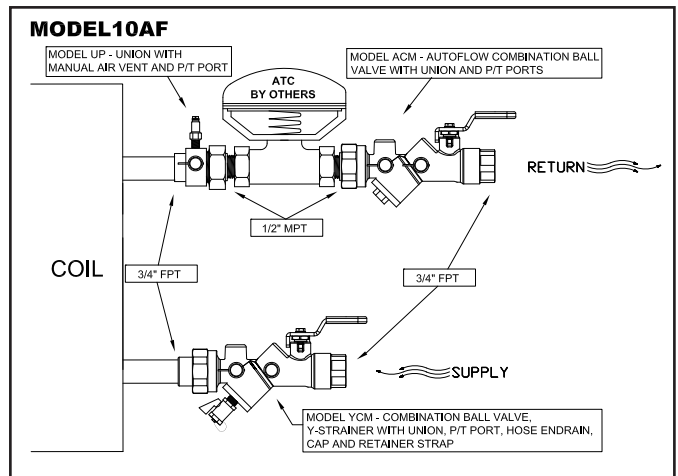
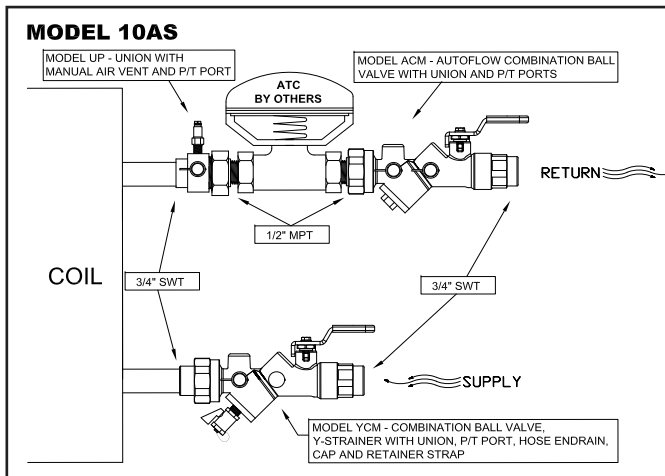
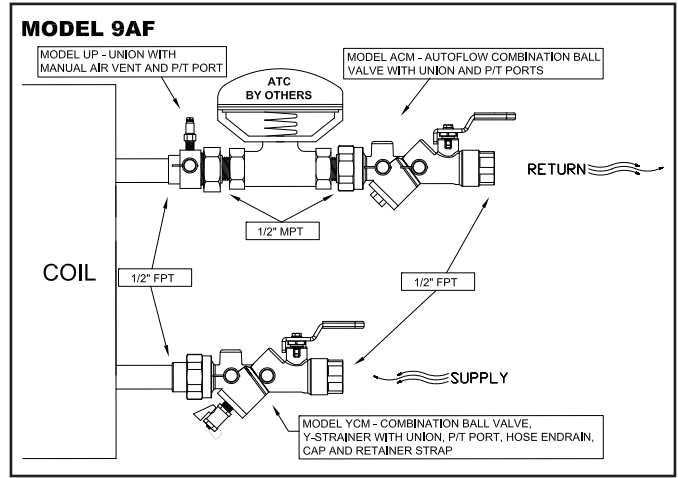
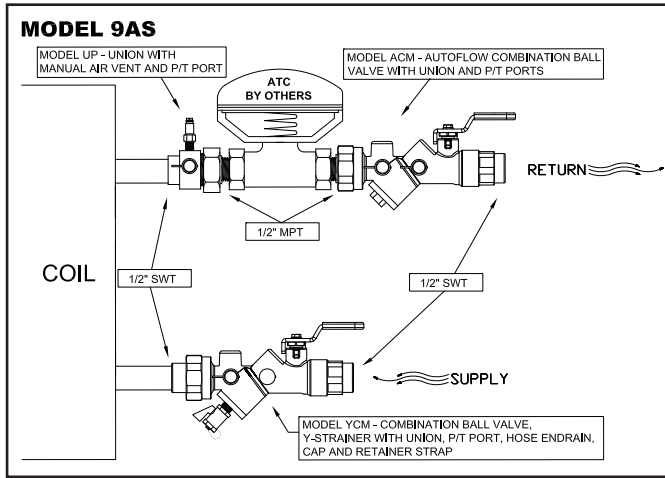

**Flow Rates**

**Available Flow Rates for 1A – 8A Packages**

gpm (lps)

1A-2A Flows:	0.50 (.03)	.075 (.05)	1.00 (.06)	1.25 (.08)	1.50 (.09)	1.75 (.11)	2.00 (.13)	2.50 (.16)	3.00 (.18)	
3A-9A Flows:	0.50 (.03)	.075 (.05)	1.00 (.06)	1.25 (.08)	1.50 (.09)	1.75 (.11)	2.00 (.13)	2.25 (.14)	2.50 (.16)	3.00 (.18)
	4.00 (.25)	4.5 (.28)	5.00 (.32)	6.00 (.38)	7.00 (.44)	8.00 (.50)	9.00 (.57)	10.00 (.63)	11.00 (.69)	12.00 (.76)

**Notes**

All configurations include an automatic flow regulator with ±5% accuracy over the 2-32 psid control range. For product specific information, please see individual product submittals.

**Program**

Please do not combine *complete coil hook-up package* purchase orders with standard or QuickShip purchase orders.

No changes are allowed to the product mix, accessories, flows or configuration; standard orders will be processed if changes are required.

Maximum order is 300 hook-ups without factory consultation. Please contact factory for quantities exceeding the maximum.

\*No special tagging, gpm only.

**Model Order Designation**

**Model Name**

Use on all hook-up packages

**Flow Rate**

Use to designate flow rate  
*Rate shown in gpm*

**HU - 1AS - 0.50**

**Package Configuration**

Use to show Hook-up model number

FS = female sweat    MS = male sweat    FT = female thread    MT = male thread

**Notes**

Pricing includes "Bag & Tag"

HU-AS - Sweat Connection

HU-AF - Female Pipe Thread Connection

**Disclaimer:** The products, texts, photographs, graphics and diagrams in this submittal may be subject to alteration by Flow Design Inc. without prior notice or reason being given.

***Disclaimer:*** *The products, texts, photographs, graphics and diagrams in this submittal may be subject to alteration by Flow Design Inc. without prior notice or reason being given.*

8908 Governors Row / Dallas, Texas 75247  
1-800-ASK-FLOW / +1 214 631 0011  
[www.flowdesign.com](http://www.flowdesign.com)